



CDVI

31, av. du Gal Leclerc
93500 PANTIN FRANCE
Tel : 33 (0)1 48 91 01 02
Fax : 33 (0)1 48 91 21 21
www.cdvi.com

PROMI 1000

STAND ALONE ACCESS CONTROL SYSTEM

WIRING DIAGRAM AND INSTRUCTION



This device comes with a varistor.

The varistor must be connected on the strike terminal (electromagnet...) operated by the device.

If this product operates more than one strikes, each of them should have a varistor.

The varistor controls the overload produced by the strike coil – back emf.

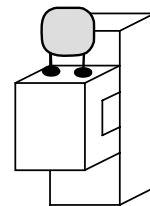

If you are using a « Shear Lock » electromagnetic lock, it is recommended to use a separate power supply than the one connected to the PROMI 1000 !

PROMI 1000 USER MANUAL

I. <u>PRESENTATION DU PRODUIT</u>	3
A. <i>Product presentation</i>	3
B. <i>Factory Default Values</i>	4
C. <i>Audible signals</i>	4
D. <i>Visual signals</i>	4
E. <i>Current consumption</i>	4
F. <i>Recommended printer</i>	4
II. <u>PROGRAMMING</u>	6
A. <i>Colors and audible signals</i>	6
B. <i>Main menu</i>	6
C. <i>Menu 00 - Program badges and Pin codes</i>	6
D. <i>Menu 01 - Operating mode</i>	7
E. <i>Menu 02 - Door release time</i>	8
F. <i>Menu 03 - Alarm time output</i>	8
G. <i>Menu 04 - Master code</i>	8
H. <i>Menu 05 - Setting date and hour</i>	9
I. <i>Menu 06 - Schedules</i>	9
J. <i>Menu 07 - Holidays</i>	10
K. <i>Menu 08 - Anti pass back</i>	10
L. <i>Menu 09 - Printer and event</i>	10
M. <i>Menu 10 - Badge enrolment unit</i>	12
N. <i>Menu 11 Delete schedules</i>	13
O. <i>Menu 12 - Delete holidays</i>	13
P. <i>Menu 13 - Setting accesses during the holidays</i>	13
Q. <i>Exit from programming</i>	14
III. <u>OPERATING INSTRUCTIONS</u>	14
A. <i>Reset</i>	14
B. <i>Operating modes</i>	15
C. <i>Lockout</i>	15
D. <i>Event printing</i>	16
E. <i>Door contact - Alarm</i>	16
F. <i>Memory</i>	17
G. <i>Anti pass - back</i>	17
H. <i>Setting Date and Hour</i>	17
V. <u>WIRING DIAGRAM</u>	20
VI. <u>TEMPLATE</u>	23



It is recommended to read the user manual to familiarize yourself with all the features and the operating instructions.

An synoptic is available at the end of the user manual.
The synoptic is usefull to have a general overview on the complete programming instructions.

I. PRESENTATION DU PRODUIT

A. *Product presentation*

- Input voltage 12V AC/DC
- 12-digit keypad with LED visual indicator
- EPROM memory storage
- Date and hour saving with 3V CR2032 battery
- 1000 programmable proximity badges and Pin codes
- 1000 event stored in memory buffer
- Up to 16 holidays
- Removable memory unit
- RS232 output
- Event thermal printing
- Printing of all events and configuration
- Print badge and code list
- Printer with or without DTR signal (MTP640 Kyoline printer recommended)
- Capability to connect an external reader up to 50 meter
- Anti pass back (PROMI 1000 to exit and reader to enter)
- 1 relay output RT contact 3A/125V-
- 1 alarm relay output N/O contact 3A/125V-
- 3 operating modes:
 - Mode 0: Badge and Pin code
 - Mode 1: Badge only
 - Mode 2: Badge or Pin code
- 3 time zones to operate the 3 operating modes
- 5-digit programmable master code
- Proximity readers and keypad lockout during 2 minutes after 3 invalid Pin code badge
- Buzzer for audible signal
- 1 request-to-exit input
- Door contact input
- Minimum distance of 60 cm between the controller and the reader

B. Factory Default Values

Operating mode: 0 badge and Pin code
Door open time: 1 second
Alarm time delay: 00 alarm disabled
Key-in keypad time: 10 seconds
Master code: 12345
No time zone
No Holiday
Anti pass back disabled
DTR signal on for printer
Programming time : 2 minuts

C. Audible signals

1 short beep	keypad digit key pressed
1 long beep	Access granted or valid data computing
2 short beeps	Start or exit from programming or invalid badge read
4 short beeps	Error computing data or badge already programmed

D. Visual signals

LED color	En lecture	En programmation
Orange flashing	Stand-by	Error computing data
Orange		Main menu
Green	Access granted	Validate computing data
Red	Alarm	Validate menu

E. Current consumption

200 mA

F. Recommended printer

MTP 640 KYOLINE KYOSHA

Paper: thermal, black printer

width 112 mm

diameter 38 mm

reference: TP50XSE2C

RS232 with DTR signal (printer on line)

9600 bauds

Dip switches set up on the printer

1 start

7 bits

Parity: even

1 stop

IBM mode

40 characters

CR = skip line

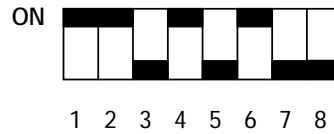

DTR signal: high: printer on line

low: printer off line

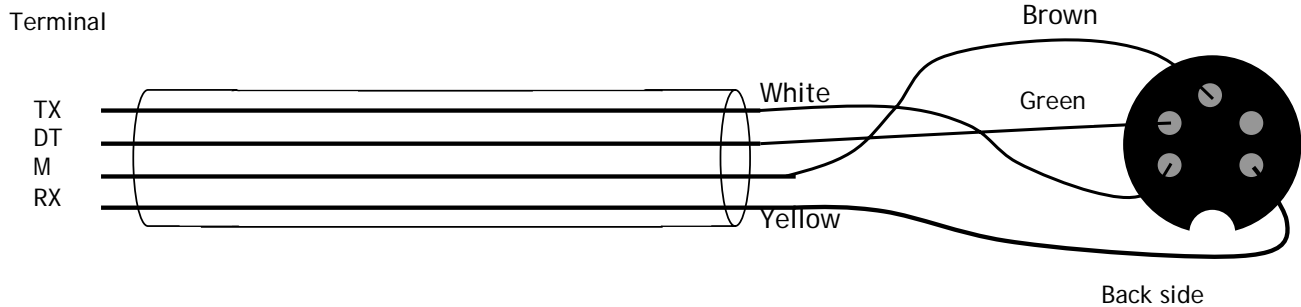

Paper error:

When paper roll is finished, the printer LED flashes fast, The data is stored in the memory buffer of the printer until it is full.

Place another paper roll in the printer and press on the feed button until the paper is placed properly and put back the top cover of the printer, the LED flashed slowly, press promptly on the feed paper button, the printer starts printing the data stored in its buffer.

The LED stops flashing.

II. PROGRAMMING

A. Colors and audible signals



The letter in bolt represents the LED color.
(O for orange, G for green and R for red)
the digit represents the number of beep emitted.



The LED turns green and the 1 beep is emitted.



The LED turns Red and 1 beep is emitted.

B. Main menu

Important: Refer to the one page programming

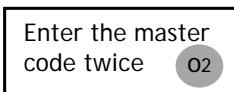

Enter the master code twice (12345 default). The LED turns on to orange and 2 audible beeps are emitted.

A time delay of 2 minutes is set before the main menu is being shut down.

Once in the main menu, the LED lights on in orange.

Enter the 2-digit number of the menu to select a menu (from 00 to 13)



Once you enter in the menu, the LED lights in red.

Press on the # to exit from programming.

C. Menu 00 - Program badges and Pin codes

Press 00 to enter in badge & Pin code programming menu. The badges and Pin codes are stored in a slot (pigeon hole) defined as a user number.

Once in the badge programming menu, an automatic search is launch to select the next available user number.

Once a free user number is selected the LED lights on in Green



--- Present the badge in front of the PROMI1000 or in front the external reader (nal reader: see *Menu 10*) 01

OR

Select a user number, enter the 3-digit user number from 000 to 999

--- If the user number is available the LED lights on in Green G1 present the badge in front the PROMI 1000 or in front of the external reader 01

--- If the user number is not available R1 enter another user number or press on * twice G1 to delete the badge and Pin code.

Then present a badge in front of the PROMI 1000 or external reader.

--- Enter the 5-digit Pin code 01

OR

--- Press * to skip the pin code 01

Another search is launch to select an available user number.

When all the user numbers are full then the PROMI 1000 displays an error. 04

An error is displayed when a badge has been already programmed 04

If the printer is connected during the programming then the user number, code of badge and Pin code are printed.

The last 8-digit of the code of the badge are printed.

D. Menu 01 - Operating mode

Press 01 to enter in the operating mode menu

Press 0 to select Badge & Pin code operating mode.

The LED lights on in green G1

OR

Press 1 to select badge only operating mode.

The LED lights on in green G1

OR

Press 2 to select badge OR Pin code operating mode.

The LED lights on in green 

Then press #.

Press # go back to MENU

 The PROMI 1000 returns to the main menu 

E. Menu 02 - Door release time

Enter 02 to enter in the door release time menu

Enter the time in seconds from 01 to 99 for a momentarily output or 00 for a latched output.

The LED lights on in green 

Then press #.

Press # go back to MENU

 The PROMI 1000 returns to the main menu 

F. Menu 03 - Alarm time output

Enter 03 to enter in the alarm time output menu

Enter the time in seconds per 10 seconds (01 to 99) and 00 to disable the alarm.

01 pour 10s et 99 pour 990s.

The LED lights on in green 

Then press #.

Press # go back to MENU

 The PROMI 1000 returns to the main menu 

G. Menu 04 - Master code

Press 04 to enter in the master code menu

Enter the new 5-digit master code. The LED lights on in green 

Then press #.

Press # go back to MENU

 The PROMI 1000 returns to the main menu 

H. Menu 05 - Setting date and hour

Enter 05 to enter in the date and hour menu

Enter the hour and minutes then the day, month, year and the week day **G1**

Week day: Monday ----- enter 1
Tuesday ----- enter 2
Wednesday --- enter 3
Thursday ----- enter 4
Friday ----- enter 5
Saturday ----- enter 6
Sunday ----- enter 7

Example: 09h26, 02 September 2003, Tuesday.

Enter 09 26 02 09 03 2

Then press #.

Press # go back to MENU

 The PROMI 1000 returns to the main menu **O1**

I. Menu 06 - Schedules

Press 06 to enter in the schedule menu

Each operating mode can be associated with one schedule.

Enter the schedule number of the operating mode **R1**

0 for the schedule of the operating mode 0
1 for the schedule of the operating mode 1
2 for the schedule of the operating mode 2

Enter the hour and the minutes for the start time then the hour and the minutes for the stop time

And the week day **G1**

Week day: Everyday ----- enter 0
Monday ----- enter 1
Tuesday ----- enter 2
Wednesday ----- enter 3
Thursday ----- enter 4
Friday ----- enter 5
Saturday ----- enter 6
Sunday ----- enter 7
Monday to Friday ----- enter 8
Saturday and Sunday --- enter 9

Example: start time 9h30, stop time 22h50, Monday to Friday.

Enter 09 30 22 50 8

Then press#.

Press # go back to MENU

 The PROMI 1000 returns to the main menu **O1**

J. Menu 07 - Holidays

Press 07 to enter in the holidays menu

16 different holidays can be programmed, enter the a holiday number from 01 to 16 **R1**

Then enter the day and month for this holiday

Example: 25 October, enter 25 10

The LED lights on in green **V1**

Then press #.

Press # to go back to the Main MENU

 The PROMI 1000 returns to the main menu **01**

OR

Enter another holiday.

K. Menu 08 - Anti pass back

Press 08 to enter in the anti pass back menu

Press 0 to deactivate the anti pass back mode. Wait 5 seconds for the complete deactivation.

Press 1 to activate the anti pass back. The PROMI 1000 must be used as the exit reader and the remote reader as the entry reader.

The LED lights on in green **G1**

Then press #.

Press # to go back to the Main MENU

 The PROMI 1000 returns to the main menu **01**

L. Menu 09 - Printer and event

Press 09 to enter in the printer setup and event printing menu

Press 0 to delete all the events from the controller **R1** then press # to confirm **R1** wait 15 sec

The LED lights on in green **G1**

Then press #.

Press # to go back to the Main MENU

 The PROMI 1000 returns to the main menu **01**

OR

Press 1 to print all the events stored in the memory buffer **G1** then press # to confirm **G1**

To stop the printer at any time keep pressing on the 0 key until the LED lights on in green and a beep is emitted.

At the end of the printing the a message "END PRINTING" appears on the report.

The LED lights on in green 

Then press #.

Press # to go back to the Main MENU

 The PROMI 1000 returns to the main menu 

OR

Press 2 to print the configuration report of the PROMI 1000 control unit.

```
-----START PRINTING-----  
  
Mod 2   Touv 01s   Talarm 640s   Mait 12345  
DTR off   Pass back on  
  
-----  
Schedule mode 0   12.56  14.23  0  
Schedule mode 1   13.19  15.45  3  
Schedule mode 2   19.12  22.47  7  
  
-----  
Holiday 01.01  
Holiday 16.02  
Holiday 01.04  
Holiday 08.05  
Holiday 14.07  
Holiday 15.08  
Holiday 25.10  
Holiday 11.11  
Holiday 31.12  
Holiday 15.12  
  
-----END PRINTING-----
```

Mod = Operating mode
Touv = door release time
Talarm = alarm output time
Master = Master Code

The LED lights on in green 

OR

Press 3 to print all the code of badge and Pin code. To abort the printing report, keep pressing on the 0 key until the LED lights on in green and a beep is emitted.

-----START PRINTING-----			
User number	Badge	Code	Username
000	022DC567	12458	
001	023ABD99	54831	
002	023AA1C0		
003	023A9305	89657	
004	02397F8A	55632	

Only the last 8-digit of the code of the badge are printed on the report.

The LED lights on in green **G1**

Then press #. Press # to go back to the Main MENU The PROMI 1000 returns to the main menu **01**

OR

Press 4 if the DTR signal is off on the printer.

The LED lights on in green **G1**

OR

Press 5 if the DTR signal is on the printer (printer on line)

The LED lights on in green **G1**

Then press #. Press # to go back to the Main MENU The PROMI 1000 returns to the main menu **01**

M. Menu 10 - Badge enrolment unit

Press 10 to enter in the badge enrolment unit menu

The default badge enrolment unit is the controller built-in reader.

Press 0 to select the controller built-in as the badge enrolment reader, press 1 to select the remote reader as the badge enrolment reader.

The LED lights on in green **G1**

Then press #. Press # to go back to the Main MENU The PROMI 1000 returns to the main menu **O1**

To program badges and Pin code select *Menu 00*.

The built-in reader of the controller is set back as the default badge enrolment unit once you exit from programming.

N. Menu 11 Delete schedules

Press 11 to enter in the delete schedule menu

Enter the schedule of the operating mode to delete **R1**

0 to delete schedule of operating mode 0

1 to delete schedule of operating mode 1

2 to delete schedule of operating mode 2

Press on * twice to delete the schedule **G1**

Then press #. Press # to go back to the Main MENU The PROMI 1000 returns to the main menu **O1**

O. Menu 12 - Delete holidays

Press 12 to enter in the delete holiday menu

Enter the holiday number to delete (from 01 to 16) **R1**

Press * twice to delete the holiday. The LED lights on in green **G1**

Then press #. Press # to go back to the Main MENU The PROMI 1000 returns to the main menu **O1**

OR

Enter another holiday number.

P. Menu 13 - Setting accesses during the holidays



Press 13 to enter in the setting holiday menu

Enter the user number (000 to 999)

The LED lights on in red **R1**

Press 1 to authorize the access for the selected user number (cardholder) or press 0 to deny access for the selected user number during the holidays.

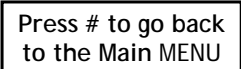
The LED lights on in green 

Then press #.  The PROMI 1000 returns to the main menu 

OR

Press * to authorize the access to all the cardholder 

Press # to confirm and wait 5s until the new configuration is set for all the cardholder.



The LED lights on in green 

OR

Press # to deny access to all the cardholder during the holiday periods 

Press # to confirm your choice and wait 5 seconds until the new configuration is set for all the cardholder.

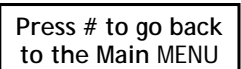
The green LED lights on 

Then press #.  The PROMI 1000 returns to the main menu 

Q. Exit from programming

You must be in the main menu to exit from programming, press #



Once you exit from programming the PROMI 1000 is on stand-by the LED flashes in orange.

III. OPERATING INSTRUCTIONS

The key-in time between two digit is set at 10 seconds. Behind that time the data computed is canceled.

A. Reset

Place the ST1 jumper in 2-3 position.

The LED flashes in green during 5 seconds. The default master code is restored to 12345.

The LED flashes in red and a beep is emitted.

Remove the jumper from 2-3 position then the unit goes back to stand-by mode.

OR

Keep the jumper on 2-3 position to reset the badges, pin codes, schedules and holidays from the PROMI 1000 memory.

The LED flashes in red during 5 seconds then the LED lights on in red during the reset.

The LED starts flashing in orange when the reset is completed and a beep is emitted.

Remove the jumper from 2-3 position to go back to stand-by mode.

OR

Keep the jumper on 2-3 position to reset the events.

The LED flashes in orange during 5 seconds then lights on in orange during the reset.

The LED lights off when the reset of all the events is completed.

Remove the jumper from 2-3 position to go back to stand-by mode.

B. Operating modes

--- Mode 0 (badge and Pin code)

Present the badge in front of the PROMI 1000 unit. A beep is emitted when the badge is valid. Enter the 5-digit pin code. If the Pin code is valid the relay is activated and the access is granted. Two beeps are emitted to indicate that the badge or Pin code are invalid.

--- Mode 1 (badge only)

Present the badge in front of the PROMI 1000 unit. The access is granted if the badge is valid. Two beeps are emitted to indicate that the badge is invalid.

--- Mode 2 (badge or Pin code)

Present the badge in front of the PROMI 1000 unit. The access is granted if the badge is valid. Two beeps are emitted to indicate that the badge is invalid.

OR

Enter the 5- digit Pin code. If the Pin code is valid the access is granted.

C. Lockout

After 3 incorrect badge and/or PIN code are entered, the PROMI 1000 reader and the second proximity reader are locked out during 2 minutes and the alarm relay is activated. 2 audible beeps sound when the badge/PIN code are not valid. The LED lights on in red during the time of the lockout. The LED flashes in orange when the lockout is finished.

D. Event printing

When a badge is presented or a Pin code is entered, the user number code of badge or Pin Code date, hour and operating mode are printed.

	User number	Code of badge	Date	Heure	
Valid badge	521	Badge 022DC567	25.09.03	17.38	2
Invalid badge	xxx	Badge 0236AD7C	25.09.03	17.40	2

The last 8-digit of the code of the badge are printed.

1000 events are stored in the memory buffer of the controller. The 1001 event replaces the first one.

E. Door contact - Alarm

The tamper switch activates the relay of the alarm when the front panel is removed. If the alarm time delay is different to 00, the door monitoring (door ajar or door forced open) is enabled:

When the door is opened, without being activated by the request-to-exit button or a badge, the alarm relay is activated after 1 second and the red LED lights on (forced open door).

When the badge or the request-to-exit button are used to open a door, if the door stays open, the open contact will trigger the alarm relay according to the door relay output.

Momentary output

The alarm time delay begins at the end of the door release time. If the door is maintained open after the alarm time delay, the alarm relay is activated and the red LED lights on. Closing back the door will deactivate the alarm relay and the LED start flashing orange.

Latched output

The alarm time delay begins only when the door stays open after ordering the closing by presenting back the badge or pressing on the request-to-exit button, the alarm relay is activated and the red LED lights on. Closing back the door will deactivate the alarm relay and the LED flashes orange.

Note:

1. During an alarm the reader and the request-to-exit are enabled.
2. To cancel the alarm go to **Menu 03** in programming and enter **00**.

Events

Quand l'alarme est commandée (forced door open, door ajar or lockout alarm) the following messages are printed on the event report «Alarm» and «Alarm end» with the day and hour of the event.

Event	Date	Heure	Mode
Alarm	25.09.03	17.38	2
Alarm cleared	25.09.03	17.44	2

F. Memory

The memory unit on the PROMI 1000 can be removed. The time outputs, the schedules, the holiday periods, the badges, the Pin codes and the events are stored in the memory unit.

All the data on the memory

G. Anti pass - back

To start the anti passback mode go to *menu 08*. The PROMI 1000 must used as an exit unit and the remote reader as the entry reader.

It is important to present the badge on the entry reader and on the exit reader. The access is granted only when the badge was presented on the exit reader.

H. Setting Date and Hour

The PROMI 1000 has a built-in clock calender with time and date. The clock must always be powered by the 12V power supply or the 3V CR1225 battery.

The battery is used only in case of power failure.

IV. PROGRAMMING DIAGRAM

PROMI 1000

Key-in programming time: 2minutes and key-in keypad time: 10 seconds, no schedule no holiday

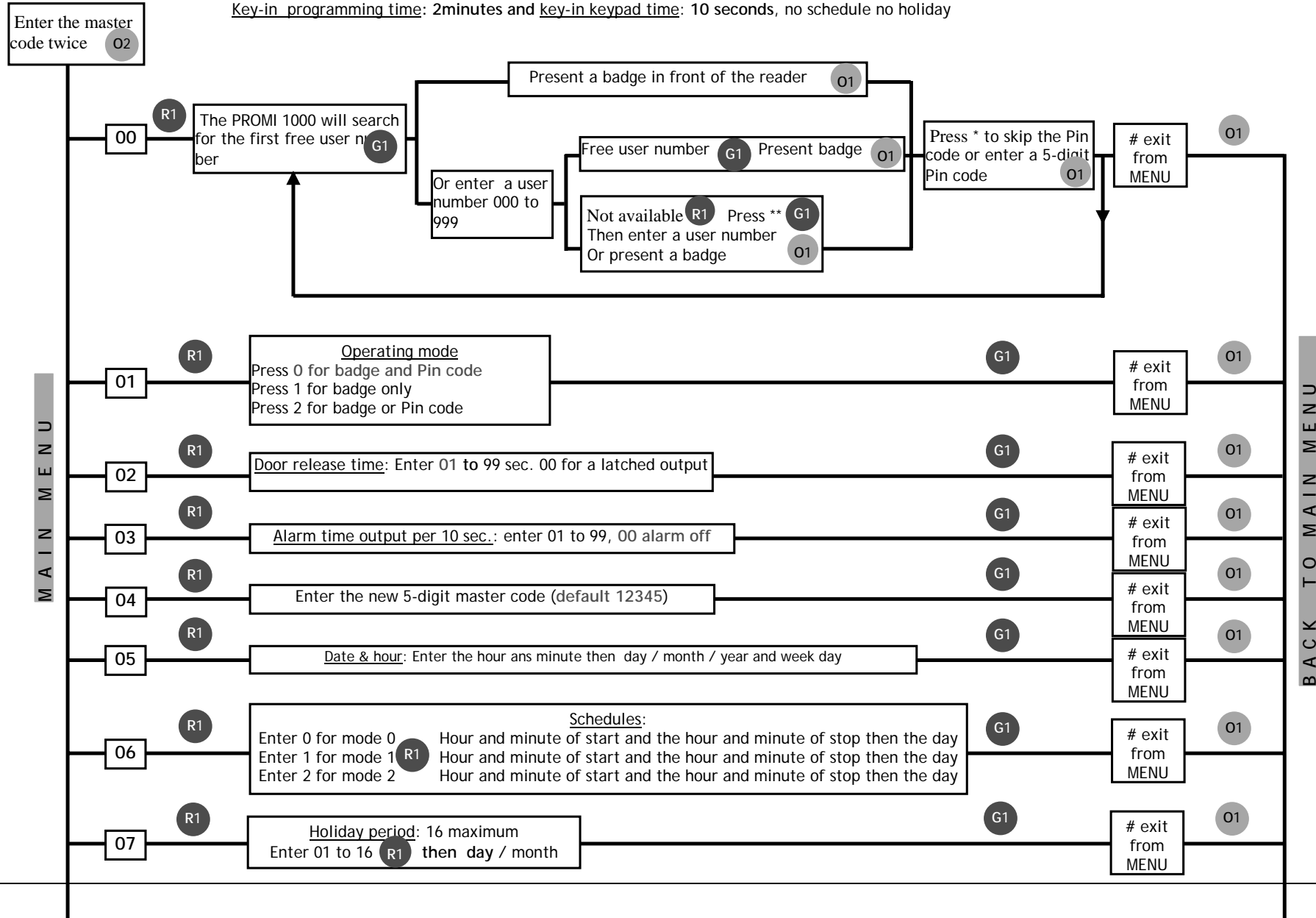

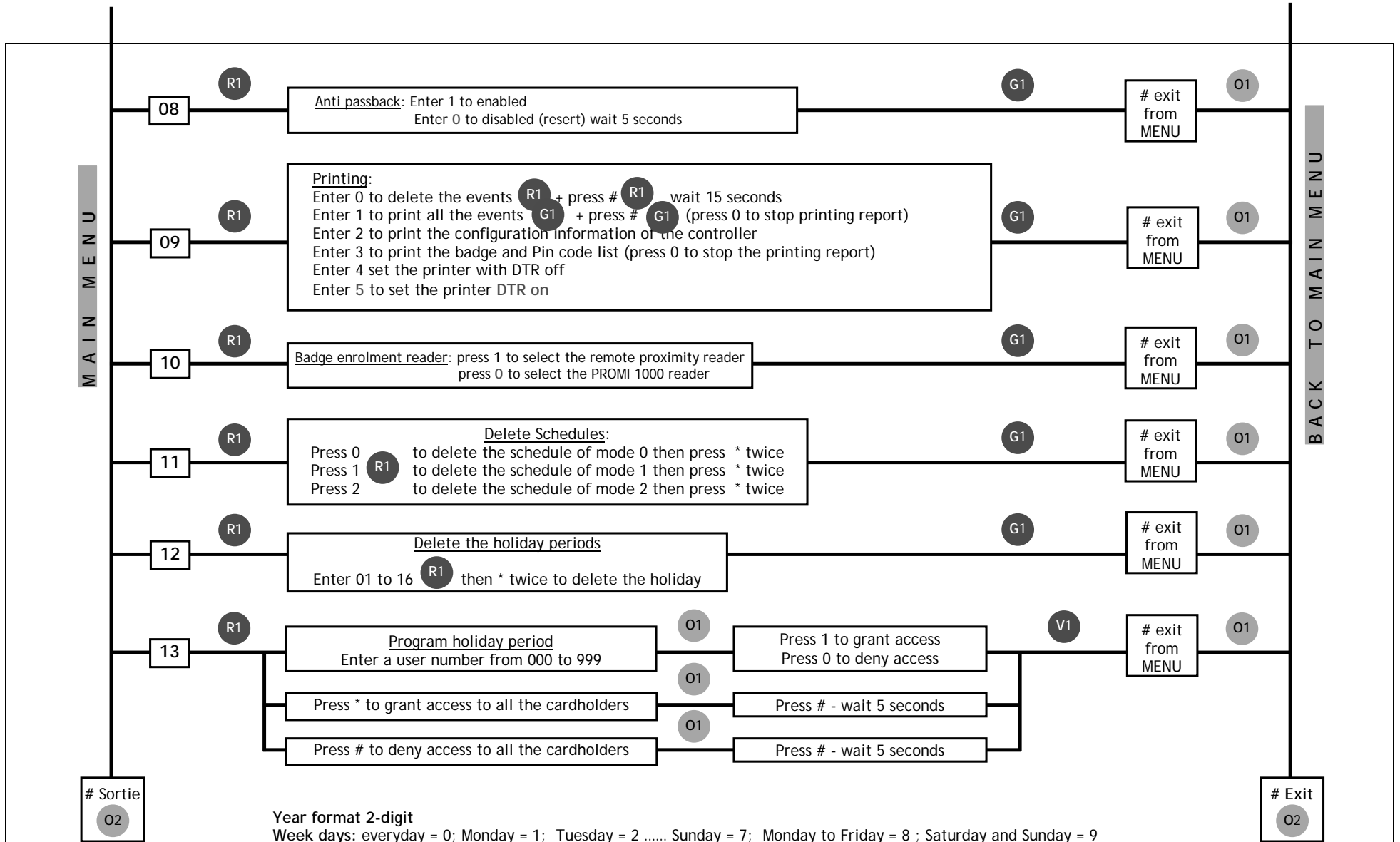

Signalétique

O2 Orange LED with 2 beeps validate

data computing error

O4 then **R**

Bolt, default values

V. WIRING DIAGRAM

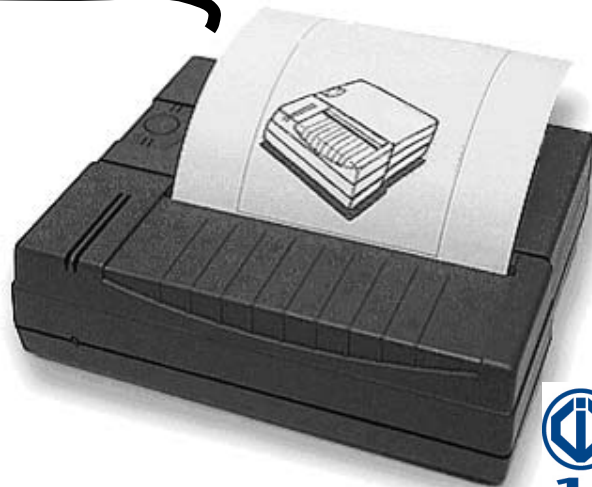
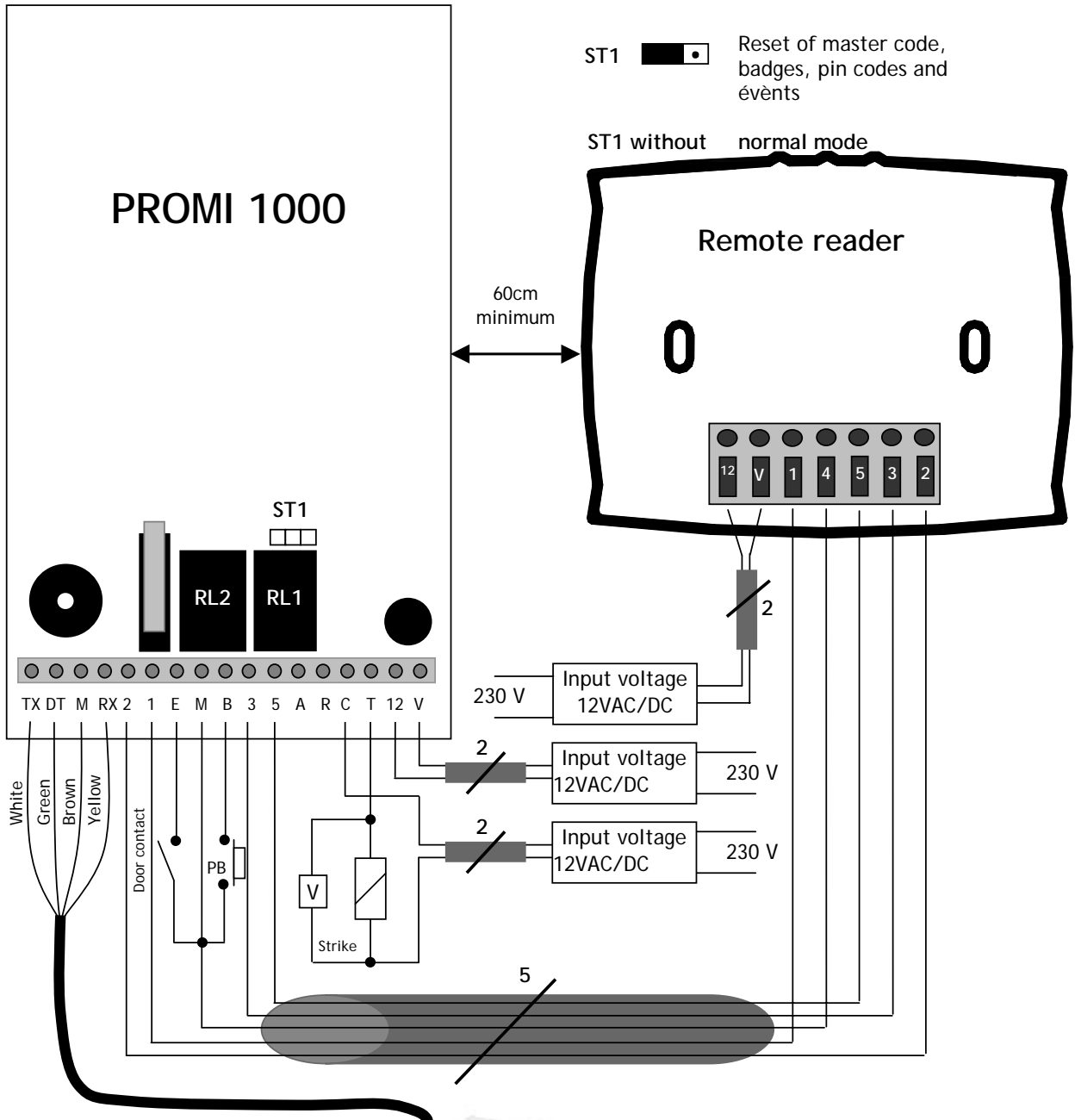

The PROMI 1000 and the remote reader must be separated between each other by 60 cm.

Also, if two PROMI 1000 are installed next to each other a distance of 60 cm must be kept between the two units.

Terminal	Signification
12	Input voltage 12VAC or DC
V	Input voltage 12VAC or DC
T	N/O contact
C	Common contact
R	N/C contact
A	N/O alarm contact
5	Remote reader red LED
3	Remote reader green LED
B	Request-to-exit input
M	Common of Push button and door contact
E	Alarm input
1	Remote reader data
2	Remote reader buzzer
RX	RX printer
M	Common printer
DT	DTR signal printer on line
TX	TX printer
	V : Varistor

VI. TEMPLATE

PROMI1000

